



SÖNMEZ MACHINE / SA-505

CÓDIGO
900006

SA -505

ÜÇLÜ KOLYERİ
DELME KOPYE
FREZEMAKİNESİ

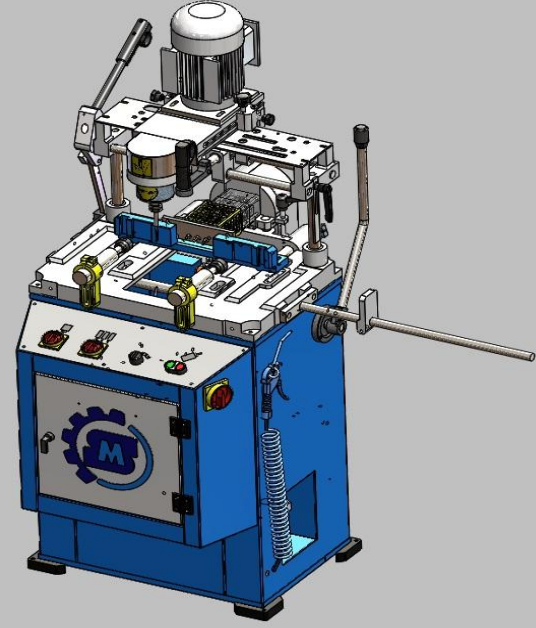

ÜÇLÜ KOL YERİ DELMELİ, KOPYE FREZE MAKİNASI

- Kopya freze bölümü kapi kolu yuvalari ve kanat profiline ispanyolet kanallarini açar
- Üçlü delme bölümü kanatlara kol yeri deliklerini açar.
- Kopya freze sablon takip ucunun rehberliğinde el ile kumanda edilir.
- PVC profillerin su tahliye kanallarının açılmasında kullanılır.
- Motor seçimi butonlar vasıtası ile yapılır.
- Optimum çalışma süresi ile zaman kayıpları önlenir
- Pnömatik profil sıkma tertibatı vardır.
- Profil sıkma işlemi sase üzerindeki el kumanda valfi ile yapılır
- Makinanın ayarlanabilir ayakları sayesinde zemine rahatlıkla konumlandırılır.
- Freze kafaları derinliğine ve yüksekliğine açılı olarak serbest ayarlanabilir.
- CE normlarına uygun tasarım







ISO-EN 9001:2000





GOST R
PGT
1350

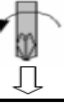
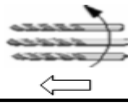

SÖNMEZ MACHINE / SA-505

TEKNİK ÖZELLİKLER TECHNICAL FEATURES							
				BAR	HAVATÜK. AIR CON.		
CF-600	1,1KW-380 V	635X460X1365	65KG
SA-505	1,1KW-380 V	0,55KW-380V	6-8	5LT/DK	635X670X1365	80KG
SA-510	1,1KW-380 V	0,55KW-380V	0,65KW-230V	6-8	5LT/DK	635X670X1365	90KG

		
30000 D/R/PM	1500 D/R/PM	26000 D/R/PM 35000 D/R/PM

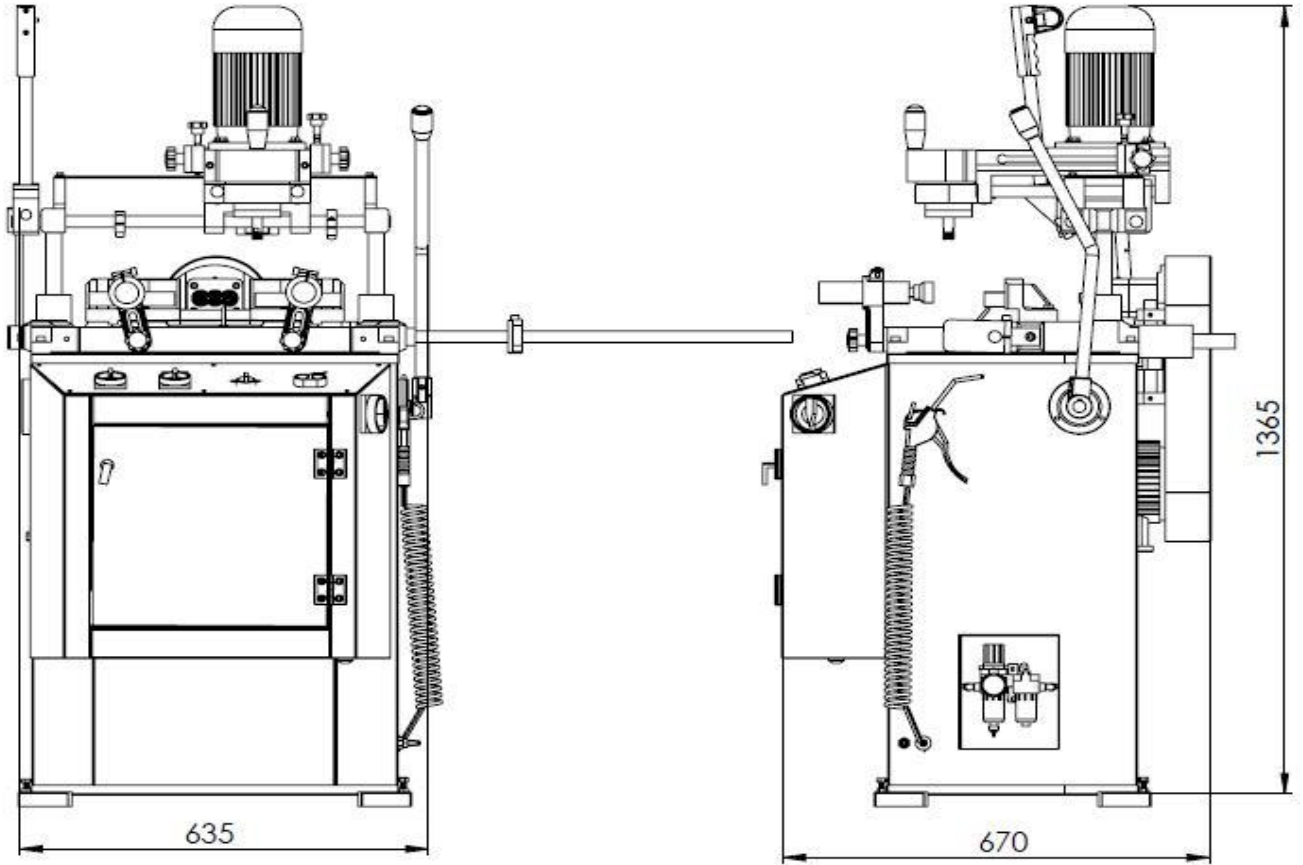

Adres : KAYAPA ORGANİZE SANAYİ BÖLGESİ LALE CADDESİ NO: 14 NİLÜFER/BURSA/TÜRKİYE
Tel: +90 224 367 33 04 / 367 04 41
Fax: +90 224 3670049
Mobil : +90 555 277 71 77
Web : www.somakpvc.com
e-mail : export@somakpvc.com

SÖNMEZ MACHINE LTD. ŞTİ.

